



**NOTICE OF PUBLIC HEARING/
SPECIAL COUNCIL MEETING
FOR THE TOWN OF MAMMOTH
WEDNESDAY JUNE 30, 2021
6:00 P.M.**

Pursuant to A.R.S. § 38-431.02(B), notice is hereby given to the members of the Town Council and to the general public that the Town Council will hold a Public Hearing of the Town Council which is open to the public on Wednesday, June 30, 2021 at the Mammoth Community Center located at 101 W. 5th Street, Mammoth, Arizona. The Town Council may hold an Executive Session, A.R.S. § 38-431.03(A)(3) and (4) for legal advice, which will not be open to the public, to discuss any Agenda items set forth below.

Public access to the Mayor and Council Chambers will be restricted in order to prevent a large or close gathering of the members of the public and to promote social distancing. Additionally, some items on the agenda may be shortened, continued to a future meeting or taken out of order. These steps are part of the effort to limit the number of people who must be physically present, or who might desire to be physically present, at the meeting, and to limit the time of the public meeting. No more than 50 members of the public will be admitted on a first come, first seated basis.

1. Call to Order
2. Pledge of Allegiance
3. Roll Call
 - A. Possible consideration to excuse Councilmember(s) from Meeting pursuant to Mammoth Town Code 2.04.3

4. CALL TO THE PUBLIC
5. OPEN THE PUBLIC HEARING @ _____ PM

Budget Presentation by Town Clerk.

- A. Discussion on Final Budget for Fiscal Year 2021-2022 in the amount of \$8,784,427.00
- B. Discussion on Tax Levy for Fiscal Year 2021-2022

Handicapped individuals with special accessibility needs may contact the ADA Coordinator for the Town of Mammoth at (520) 487-2331 (V/TDD)

CLOSE THE PUBLIC HEARING @ _____ PM

6. NEW BUSINESS

- A. Consideration and Possible Adoption of Resolution 2021-06 confirming the FINAL BUDGET FROM FISCAL YEAR 2021-2022 IN THE AMOUNT OF \$8,784,427

Motion is: To Accept and Sign Resolution 2021-06 Adopting the Final Budget for Fiscal Year 2021-2022 in the Amount of \$8,784,427

Motion: 1st _____ 2nd _____

Council Action: ___ Passed ___ Defeated ___ Tabled ___ No Action Taken

- B. Consideration and Possible Approval for Providing "Take Home Vehicle" for Mammoth Police Chief, 2010 Chevy Impala

Motion is: To Approve "Take Home Vehicle" for Mammoth Police Chief, 2010 Chevy Impala

Motion: 1st _____ 2nd _____

Council Action: ___ Passed ___ Defeated ___ Tabled ___ No Action Taken

- C. Direct Staff to Evaluate Available Space in Town Hall for Living Quarters for PD Personnel not to exceed \$12,000.00

Motion is: To Direct Staff to Evaluate Available Space in Town Hall for Living Quarters for PD Personnel not to exceed \$12,000.00

Motion: 1st _____ 2nd _____

Council Action: ___ Passed ___ Defeated ___ Tabled ___ No Action Taken

7. Adjourn

Motion is to adjourn this meeting at _____ PM

Motion: 1st _____ 2nd _____

Council Action: ___ Passed ___ Defeated ___ Tabled ___ No Action Taken

The undersigned hereby certifies that a copy of this notice was posted at the Mammoth Town Hall on JUNE 25, 2021 by 5:00 p.m.

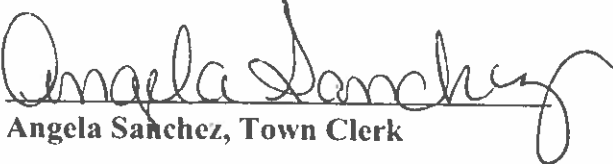
Angela Sanchez, Town Clerk

Copies of the agenda are available for public inspection at the Mammoth Town Hall and the Mammoth Public Library. Persons with disabilities needing accommodations should contact the Mammoth Town Hall coordinator at (520) 487-2331.

If possible, such requests should be made 72 hours in advance.

Town of Mammoth Arizona

FY 2021-2022 Final Budget

Adopted June 30, 2021

Resolution 2021-06

Table of Contents

Contents

- Town Clerks Budget Message 3
- FY 21-22 Final Budget Summary 4
- Expenditure Limitation Summary 5
- FY 21-22 Final General Fund Revenues 6
- Mayor and Council 7
- Administration 9
- Police Department 11
- Public Works 13
- Legal Services 15
- Magistrate 17
- Library 19
- Planning and Zoning 21
- HURF 23
- Transportation Excise Tax 25
- Grants 27
- Water Department 29
- Sewer Department 31
- Sanitation Department 33
- Cemetery Department 35

Town Clerk Budget Message



To the Mayor and Members of the Town Council:

It is a pleasure to present to you the Fiscal 2021-22 (FY22) Proposed Final Budget for your review and consideration. The preliminary estimates of the tentative budget were presented to the Mayor and Council on June 2, 2021 at the Town Council Meeting.

This year's budget process has been very different from the prior years due to a change in management staff. We have worked together to develop a budget that is realistic and functional.

The revenues were adopted with the tentative budget which established the Town's "ceiling" budget. We have not waived from that established ceiling for the Town's spending for FY22. The FY22 ceiling budget was set at \$8,784,427 compared to \$5,300,381 in fiscal year 2020-21. The increase is a direct result of additional grant funding in the amount of \$6,277,000.

The projected expenditures for FY22 include insurance and retirement for all full-time staff. We have also included capital outlay in this budget to provide housing for the Town's police officers and vehicles for both the Police Department and Public Works. In addition, we have reduced our staff by 3 positions.

In this budget we were able to reduce the food tax from 4% to 2% and there is no increase in the property tax levy, which will remain at a rate of 2.0276.

The public hearing for the final budget and property tax levy is scheduled for June 30, 2021 at 6:00 PM and the property tax levy is scheduled for adoption on July 15, 2021 at 7:00 PM.

Respectfully submitted,

A handwritten signature in black ink that reads "Angela Sanchez". The signature is written in a cursive style with a large, looping flourish at the end.

Angela Sanchez, Town Clerk

FY 21-22 Final Budget Summary

FUND	Adopted 2020-21 Budget	Estimated 2020-21 Expenditures	Proposed 2021-22 Budget	% increase (-decrease)
GENERAL	\$ 1,107,842	\$ 883,127	\$ 1,360,461	22.80%
HIGHWAY USERS	\$ 1,000,000	\$ 115,467	\$ 179,911	-82.01%
TRANS. EXCISE TAX	\$ 1,192,929	\$ 171,103	\$ 223,000	-81.31%
WATER	\$ 368,400	\$ 456,090	\$ 356,391	-3.26%
SEWER	\$ 171,750	\$ 164,677	\$ 243,104	41.54%
SANITATION	\$ 134,060	\$ 109,544	\$ 120,060	-10.44%
CEMETARY	\$ 30,400	\$ 5,598	\$ 24,500	-19.41%
GRANTS	\$ 1,295,000	\$ 395,945	\$ 6,277,000	384.71%
TOTAL ALL FUNDS	\$ 5,300,381	\$ 2,301,551	\$ 8,784,427	65.73%

Expenditure Limitations Summary

Allowable Exclusions FY21:

FY21 HURF Revenues	137,829
FY79/80 HURF Revenues	(45,013)
Excise Taxes FY21	1,090,000
Grants	<u>1,295,000</u>
Total Projected Exclusions	<u>2,477,816</u>
FY21 Expenditure Limit	3,032,586
Projected Exclusions	<u>2,477,816</u>
Total	<u>5,510,402</u>
FY21 Proposed Budget	<u>5,300,381</u>
Under Limit	210,021
Interest Income	
Donations	

Allowable Exclusions FY22:

FY22 HURF Revenues	179,911
FY79/80 HURF Revenues	(45,013)
Excise Taxes FY22	223,000
Grants	6,277,000
American Relief Act	<u>281,712</u>
Total Projected Exclusions	<u>6,634,898</u>
FY22 Expenditure Limit	3,092,922
Projected Exclusions	<u>6,634,898</u>
Total	<u>9,727,820</u>
FY21 Proposed Budget	<u>8,784,427</u>
Under Limit	943,393
Interest Income	
Donations	

FY 21-22 Final General Fund Revenues

TOWN OF MAMMOTH General Fund Revenues	Adopted Budget FY21	Actuals to 3-31-21 FY21	Estimated 6-30-21 FY21	Proposed Budget FY22
10-00-00				
Property Tax	51,586	52,377	53,000	51,544
Sales Tax (Local)	281,939	299,645	399,527	359,527
Drug & Gang Enforcement			-	-
Business Licenses & Permits	2,550	2,892	3,856	3,000
Building Permits	100	60	80	100
Liquor Licenses & Permits			-	-
State Sales Tax	157,299	152,268	203,024	198,080
State Revenue Sharing (Income Tax)	241,096	180,822	241,096	221,113
Auto Lieu Tax	107,874	83,251	111,002	113,660
Southwest Gas Franchise	6,859	4,170	5,559	6,860
Clear Channel Lease	1,200	900	1,200	1,200
AT & T Lease	-	-	-	-
Ball Field Lights/Deposits		-	-	100
Park & Rec. Contributions	4,390	-	-	-
Swimming Pool Receipts	10,800	2,974	3,965	7,000
Police Revenues	7,700	16,709	22,279	5,000
Fiesta Community Corp.		-	-	-
Court Fines & Forfeitures	11,700	6,484	8,646	10,000
Fare Fee Special Collections		-	-	-
FARE Delinquency Fee		(35)	(35)	(35)
Library Fees		-	-	-
Rental Income	21,600	-	-	21,600
Grant Library	1,500	-	-	1,000
Misc. Revenues	6,000	8,666	11,555	6,000
Revenue Transfers In-Water Fund		-	-	-
Revenue Transfers In-Grant Fund				73,000
Fund Balance Carryforward				-
AZ Cares Act.	193,679	193,679	193,679	
AMERICAN RECOVERY ACT				281,712
TOTAL GF REVENUES	1,107,872	1,004,863	1,258,433	1,360,461

Mammoth Arizona

FY 2021-2022

Final Budget

Mayor and Council



Mayor and Council

TOWN OF MAMMOTH General Fund Expenditures	Adopted Budget FY21	Actuals to 3-31-21 FY21	Estimated to 6- 30-21 FY21	Proposed Budget FY22
<u>Mayor and Council</u>				
Office Supplies	100	393.28	524	500
Travel	500	0	-	0
Election	2,000	630	840	1,000
Community Promotion		25.33	34	50
Insurance		0	-	-
Miscellaneous	500	212.11	283	250
10-42 Mayor & Council	3,100	1,261	1,681	1,800

Mammoth Arizona

FY 2021-2022

Final Budget

Administration

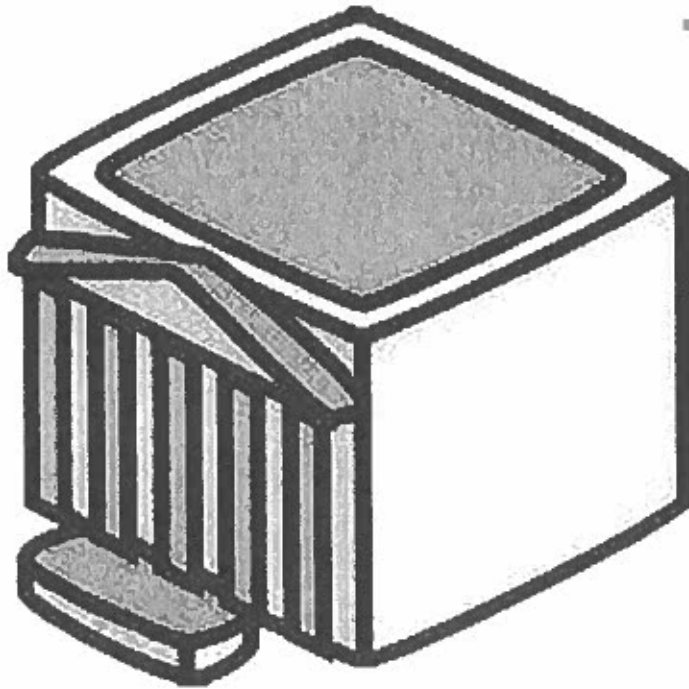

Administration

TOWN OF MAMMOTH

General Fund

Expenditures

Administration

Salaries	66,487	49,093	65,457	111,306
Employees Benefits	5,261	4,905	6,540	28,170
Office Supplies	1,500	1,065	1,420	1,615
Dues/Subscriptions	14,000	48	65	10,000
Public Notice/Advertising	1,500	631	842	1,000
Travel & Conventions		-	-	-
Postage	500	2,495	3,327	500
Equipment Maintenance	800	688	917	1,000
Vehicle Maintenance	1,000	221	295	1,000
Telephone	6,500	4,746	6,328	6,000
Utilities	2,400	1,985	2,646	2,400
Building Maintenance	1,000	468	624	500
Data Processing	14,000	16,363	21,818	15,000
Accounting & Auditing	30,000	58,045	77,393	30,000
Copier	1,800	1,267	1,689	1,500
Miscellaneous	8,500	6,855	9,140	8,500
Capital Outlay Computer Equip.		-	-	-
Capital Outlay Vehicle		-	-	-
Capital Outlay Bldg./Furniture		-	-	-
CPA Contract	10,000	-	-	5,000
Debt		-	-	-
Contingency Reserve	258,508	-	-	174,406
Administration	423,756	148,875	198,500	397,897

Mammoth Arizona

FY 2021-2022

Final Budget

Police Department



Police Department

TOWN OF MAMMOTH

General Fund

Expenditures

Police

Salaries	312,295	244,311	325,747	350,064
Employee Benefits	146,016	121,920	162,560	180,584
Office Supplies	1,200	6,208	8,278	7,700
Dues, Subscriptions & Membership	1,000	2,053	2,737	3,100
Travel & Convention	250	-	-	250
Supplies & Postage	500	124	166	300
Radio & Equipment Maintenance	800	1,175	1,567	1,200
Vehicle Maintenance	5,200	3,383	4,511	5,000
Gasoline & Oil	6,000	3,156	4,208	7,500
Telephone	7,000	5,244	6,992	8,000
Utilities	4,000	2,623	3,497	4,000
Building Maintenance & Equipment	1,200	175	233	1,200
Uniform Allowance	500	657	876	1,000
Ammunition	250	61	81	1,000
Audit	800	-	-	800
Animal Control	700	207	276	4,000
Insurance - Liability	7,000	5,130	6,840	7,000
Miscellaneous	1,500	1,606	2,141	1,600
Capital Outlay- Equipment	2,000	-	-	12,000
00 Police	498,211	398,033	530,711	596,298

Mammoth Arizona

FY 2021-2022

Final Budget

Public Works

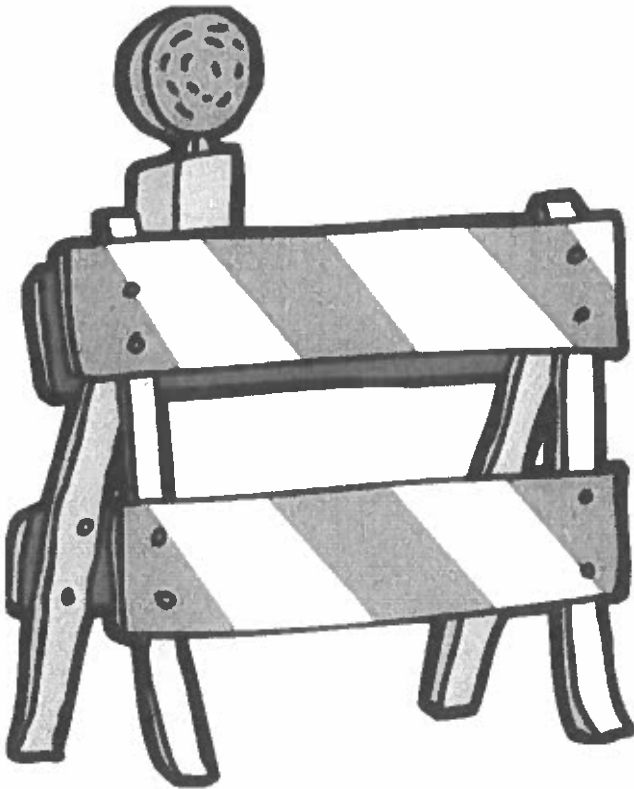

Public Works

TOWN OF MAMMOTH

General Fund

Expenditures

Public Works

Salaries	12,000	8,606	11,474	71,771
Employee Benefits	1,000	680	907	21,604
Equipment Maintenance	1,000	775	1,034	2,500
Vehicle Maintenance	400	168	223	2,188
Gasoline and Oil		-	-	1,000
Telephone	780	585	780	780
Utilities	12,500	14,485	19,314	20,000
Building/Grounds Maintenance	1,500	604	805	1,000
Pool Maintenance	1,000	-	-	1,000
Pool Chemicals	2,500	828	1,104	5,000
Insurance	3,300	1,712	2,283	2,500
Miscellaneous		432	576	500
Restrooms		-	-	-
Pool	200	420	560	1,000
Community Center	1,000	140	187	500
Fiesta Community Corp.	-	50	67	100
Parks & Recs Center	20	20	27	100
Capital Outlay			-	46,000
00 Public Works	22,800	29,504	39,338	177,543

Mammoth Arizona

FY 2021-2022
Final Budget

Legal Services

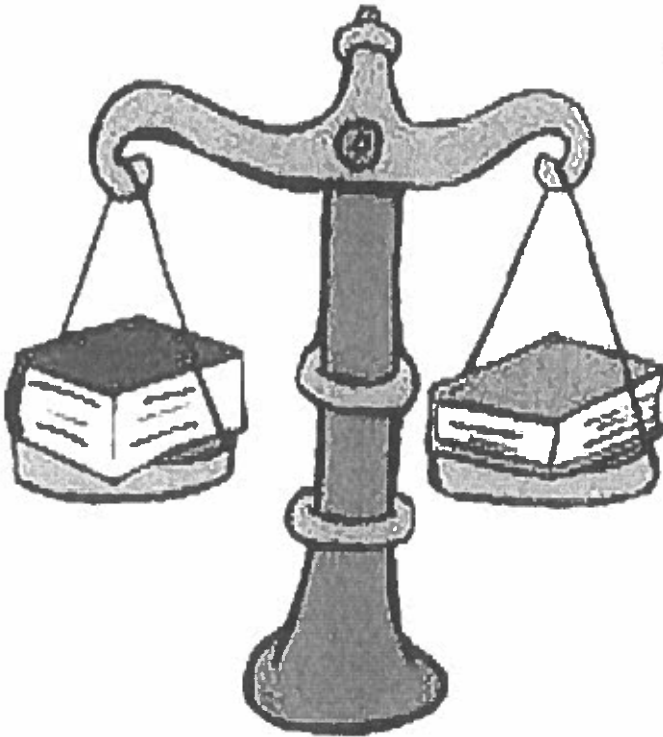

Legal Services

TOWN OF MAMMOTH

General Fund

Expenditures

<u>Attorney</u>			-	
Travel		-	-	-
Legal	40,000	32,437	43,249	40,000
Defending Attorney Fees		-	-	-
Attorney	<u>40,000</u>	<u>32,437</u>	<u>43,249</u>	<u>40,000</u>

Mammoth Arizona

FY 2021-2022

Final Budget

Magistrate



Magistrate

TOWN OF MAMMOTH

General Fund

Expenditures

Magistrate

Salaries	21,767	16,123	21,498	21,767
Employee Benefits	1,722	1,389	1,852	1,722
Education and Training		-	-	-
Office Supplies	600	-	-	600
Postage		-	-	-
Travel & Conventions	325	-	-	300
Def. Attorney Fees	12,100	-	-	12,000
Computer Maintenance	2,250	1,153	1,538	2,000
Miscellaneous	1,000	-	-	500
Court Reporter		-	-	-
00 Magistrate	39,764	18,666	24,887	38,889

TOWN OF MAMMOTH

General Fund

Expenditures

Detention Services

Jail Fees	3,000	2,487.85	3,317	3,500
00 Detention Services	3,000	2,488	3,317	3,500

Library

TOWN OF MAMMOTH**General Fund****Expenditures****Library**

Salaries	22,204	24,321	32,428	39,832
Employee Benefits	1,757	1,926	2,568	3,152
Travel		-	-	-
Postage		-	-	50
Office Supplies	100	-	-	100
Cleaning Supplies	500	-	-	400
Telephone	4,400	3,104	4,139	5,000
Utilities	2,500	1,673	2,231	2,500
Building Maint/Equip.	500	48	64	500
Insurance		-	-	2,000
Miscellaneous		-	-	-
Capital Outlay/State Grant		-	-	-
Capital Outlay Books		-	-	-
00 GENERAL FUND/LIBRARY	31,961	31,073	41,431	53,534

Mammoth Arizona

FY 2021-2022

Final Budget

Library

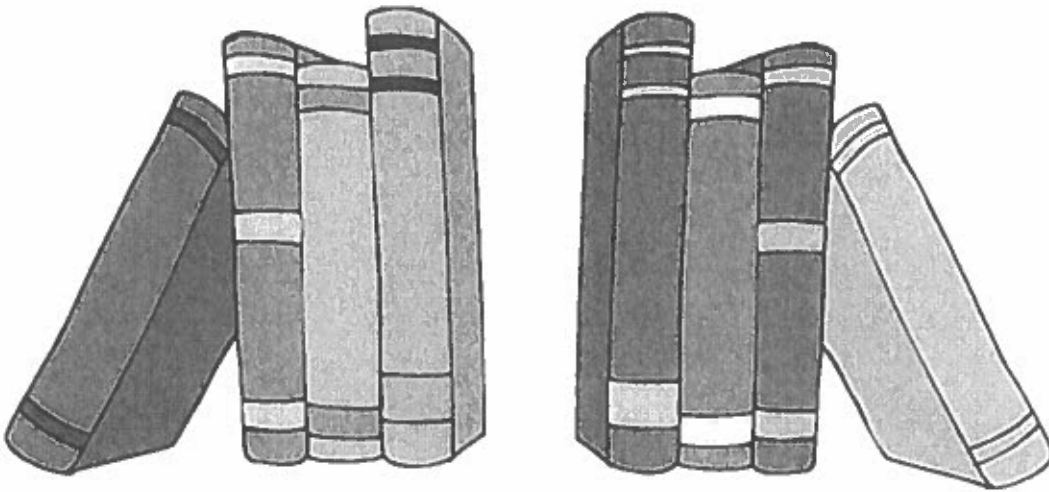

Mammoth Arizona

FY 2021-2022

Final Budget

Planning and Zoning

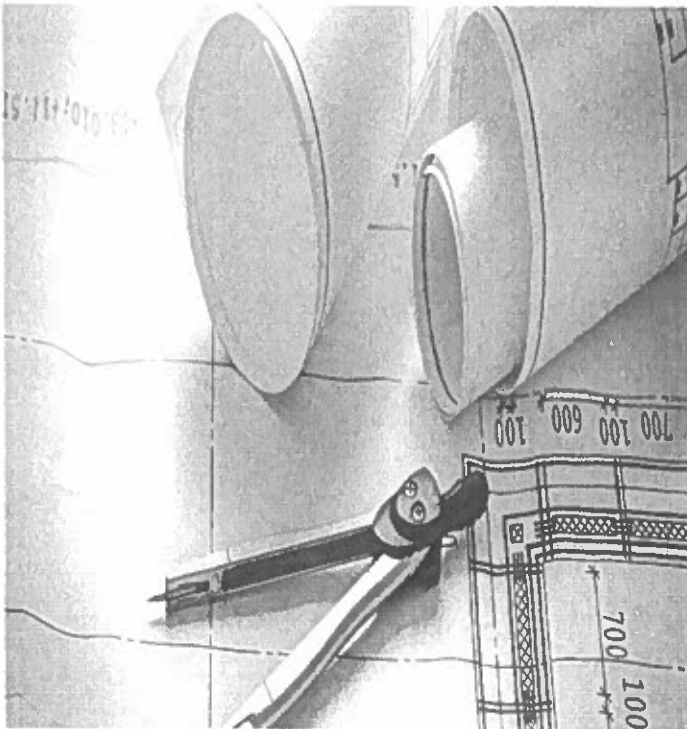

Planning and Zoning

TOWN OF MAMMOTH

General Fund

Expenditures

P/Z Board

Office Supplies

Travel/Education

Miscellaneous

250	-	-	5,000
250	-	-	5,000

P/Z Board

Mammoth Arizona

FY 2021-2022

Final Budget

Highway Users

Revenue Fund



Highway Users Revenue Fund

TOWN OF MAMMOTH HURF FUND	Adopted Budget FY21	Actual as of 3- 31-21 FY21	Estimated to 6- 30-21 FY21	Proposed FY22
Revenues				
Highway User Revenues	137,829	130,136	173,514	134,911
Payback from General Fund	45,000	-	-	45,000
LTAf Matching Fund Revenue		-	-	-
Interest Income		-	-	-
One time state allocation for streets		-	-	-
Carryforward Fund Balance	817,171	-	-	-
TOTAL HURF REVENUES	1,000,000	130,136	173,514	179,911

Expenditures	Adopted Budget FY21	Actual as of 3- 31-21 FY21	Estimated to 6- 30-21 FY21	Proposed FY22
Street Department				
Salaries, Regular		26,927	35,903	29,958
Employee Benefits		5,703	7,604	7,376
Office Supplies		-	-	335
Supplies, Materials & Service			58,292	90,000
Equipment Maintenance		141.50	189	30,000
Vehicle Maintenance & Operation		229.00	305	5,000
Gas & Oil		3,962.00	5,283	5,000
Transfers		5,918.50	7,891	770
Utilities		-	-	-
H/U Signage		-	-	-
Insurance, Bonds		-	-	5,000
Tools		-	-	5,000
Transfer out		-	-	-
Capital Outlay	1,000,000	-	-	1,472
Contingency		-	-	-
TOTAL HURF EXPENDITURES	1,000,000	42,881	115,467	179,911

TOTAL HURF REVENUES	1,000,000	130,136	173,514	179,911
TOTAL HURF EXPENDITURES	1,000,000	42,881	115,467	179,911

AVAILABLE/(DEFICIT)	-	87,255	58,047	0
----------------------------	----------	---------------	---------------	----------

Mammoth Arizona

FY 2021-2022

Final Budget

Transportation

Excise Tax



Transportation Excise Tax

TOWN OF MAMMOTH EXCISE TAX FUND	Adopted Budget FY21	Actual to 3-31-21 FY21	Estimated to 6-30-21 FY21	Proposed Budget FY22
Revenues				
1/2 Cent Sales Tax	1,090,000	47,612	47,612	100,000
Transfers In		216,415	216,415	123,000
Carryforward	102,929	-	-	-
One time Allocation from State Fund		-	-	-
TOTAL Excise Tax REVENUES	1,192,929	264,027	264,027	223,000
Expenditures				
Street Department				
Salaries, Regular	52,312		-	29,958
Employee Benefits	5,967		-	7,376
Office Supplies	1,500	-	-	200
Supplies, Materials & Service	4,000	215,727	157,435	20,000
Equipment Maintenance	4,000	142	189	4,000
Vehicle Maint & Operation	6,500	229	305	835
Gas & Oil	10,000	3,962	5,283	10,000
Utilities	17,500	5,919	7,891	17,500
H/U Signage		-	-	-
Tools	1,000	-	-	1,000
Miscellaneous	150	-	-	201
Capital Outlay	1,090,000	-	-	131,930
TOTAL EXCISE TAX FUND EXPENDITURES	1,192,929	225,978	171,103	223,000
TOTAL EXCISE TAX FUND REVENUES	1,192,929	264,027	264,027	223,000
TOTAL EXCISE TAX FUND EXPENDITURES	1,192,929	225,978	171,103	223,000
AVAILABLE/(DEFICIT)	0	38,049	92,924	0

Mammoth Arizona

FY 2021-2022 Final Budget

Grants



Grants

TOWN OF MAMMOTH

GRANT FUND

Revenues

	Adopted Budget FY21	Actuals to 3- 31-21 FY21	Estimated 6-30-21 FY21	Proposed Budget FY22
MISC GRANT REVENUE	1,295,000	-	-	1,500,000
USDA #59940 EMG WATER LINE		30,000	40,000	-
DEMA 75% OF CONTRACTORS		127,656	170,208	-
AGO-Police Grant		10,000	13,333	-
AZ Cares Act Grant		193,679	193,679	-
American Recover Act				250,000
CDBG	-	-	-	385,000
USDA RURAL UTILITY SERVICEWATER SYSTEM	-	-	-	3,000,000
LIBRARY GRANT	-	-	-	1,000
POLICE GRANT	-	-	-	1,000
CONGRESSIONALLY DIRECTED SPENDING-SCHOOL				1,000,000
CONGRESSIONALLY DIRECTED SPENDING-POLICE				140,000
TRANSFER IN		-	-	-
FUND BALANCE CARRY FORWARD-GRANTS		-	-	-
TOTAL GRANT REVENUES	1,295,000	361,335	417,220	6,277,000

Expenditures

CDB 126-18 WATER RADIO METERS		-	-	-
USDA #59940-EMG WATER LINE		30,108	40,144	-
DEMA 75% OF CONTRACSTORS PAYMEN		259,447	345,929	-
AGO-Police Grant		7,404	9,872	-
CDBG	-	-	-	385,000
USDA RURAL UTILITY SERVICEWATER SYSTEM	-	-	-	3,000,000
LIBRARY GRANT	-	-	-	1,000
POLICE GRANT	-	-	-	1,000
CONGRESSIONALLY DIRECTED SPENDING-SCHOOL				1,000,000
CONGRESSIONALLY DIRECTED SPENDING-POLICE				140,000
MISCELLANEOUS GRANT EXPENDITUR	1,295,000	-	-	1,427,000
TRANSFER OUT		296,959	395,945	323,000
TOTAL GRANT EXPENDITURES	1,295,000	593,918	395,945	6,277,000
TOTAL REVENUES	1,295,000	361,335	417,220	6,277,000
TOTAL EXPENDITURES	1,295,000	593,918	395,945	6,277,000
REVENUES OVER (UNDER) EXPENDITURES	-	(232,583)	21,275	-

Mammoth Arizona

FY 2021-2022

Final Budget

Water Department

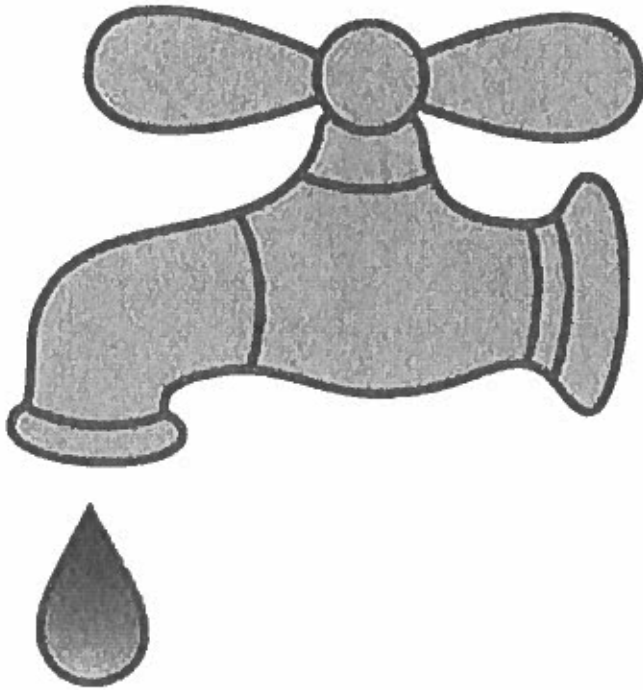

Water Department

TOWN OF MAMMOTH WATER FUND	Adopted Budget FY21	Actuals to 3-31-21 FY21	Estimated to 6-30-21 FY21	Proposed Budget FY22
Utilities Revenue				
GRANT REIMBURSEMENT				-
MISCELLANEOUS REVENUE	600	510	680	600
INTEREST INCOME				-
Capital contribution				-
FAIRFIELD AGREEMENT				-
METERED WATER SALES	366,000	189,129	252,172	300,000
TURN ON, RPR, CONNECTION FEES	1,800			2,000
CARRYOVER				-
Transfer needed from Other Funds/Rate Increase				53,791
Total Utilities Revenue	368,400	189,639	252,852	356,391

Expenditures				
SALARIES	168,043	177,810	237,080	134,667
EMPLOYEE BENEFITS	24,416	18,270	24,360	19,567
OFFICE SUPPLIES	2,000	11,433	15,244	10,000
TRAVEL & CONVENTIONS	1,000			
POSTAGE	3,500	983	1,311	8,557
EQUIPMENT MAINTENANCE/PIPE	25,000	39,441	52,588	40,000
VEHICLE MAINTENANCE	15,000	15,471	20,628	15,000
GASOLINE AND OIL	3,821	3,298	4,397	5,000
TELEPHONE	4,450	3,492	4,657	4,000
UTILITIES	35,000	32,074	42,766	40,000
BUILDING MAINTENANCE	5,000	3,162	4,216	4,000
RADIO MAINT	300			1,000
ENGINEERING & OUTSIDE SERVICES		800	1,067	15,800
AUDITING	800			800
UNIFORM EXP.		738	984	500
SAFETY EQUIPMENT	4,072			500
LEGAL FEES	2,000			1,000
INSURANCE & BONDS				9,000
LAB/CHEMICALS	4,000	4,518	6,024	6,000
TOOLS	4,000	3,395	4,526	6,000
MISCELLANEOUS	27,000	18,684	24,912	20,000
CAPITAL OUTLAY-EQUIPMENT				
WATER IMPROVEMENTS	8,500	8,499	11,332	15,000
DEPRECIATION				
CONTINGENCY				
TRANSFER TO OTHER FUNDS (PAYBACK)	30,498			
Total Expenditures	368,400	342,067	456,090	356,391

Revenues	368,400	189,639	252,852	356,391
Expenditures	368,400	342,067	456,090	356,391

Revenue Over (Under) Expenditures (1)	(0)	(152,428)	(203,238)	0
---------------------------------------	-----	-----------	-----------	---

Beginning Fund Balance			\$ (748,350)	(951,588)
Ending Fund Balance			(951,588)	(1,005,379)

Mammoth Arizona

FY 2021-2022

Final Budget

Sewer Department



Sewer Department

**TOWN OF MAMMOTH
SEWER FUND**

	Adopted Budget FY21	Actuals to 3-31-21 FY21	Estimated to 6-30-21 FY21	Proposed Budget FY22
<i>Utilities Revenue</i>				
TURN ON REPAIR & CONNECT FEE		-	-	2,000
SEWER SERVICE CHARGES	163,800	119,441	159,255	156,932
SEWER MISCELLANEOUS	150	-	-	1,000
PENALTY REVENUE	7,800	5,961	7,948	9,000
CARRYOVER/Rate increase		-	-	74,172
Total Utilities Revenue	171,750	125,402	167,203	243,104

Expenditures

SALARIES	115,627	69,260	92,346.52	118,742
EMPLOYEE BENEFITS	16,800	7,865	10,487.12	32,634
OFFICE SUPPLIES	40	1,570	2,093.97	2000
SEWER LINE MAINTENANCE	10,000	30,259	40,344.73	10000
EQUIPMENT MAINTENANCE/PIPE	4,100	647	862.21	2000
VEHICLE MAINTENANCE	500	450	600.00	600
GASOLINE AND OIL	200	-	-	200
TELEPHONE	2,100	1,904	2,539.01	2400
UTILITIES	4,000	4,059	5,411.76	5000
ENGINEERING & OUTSIDE SERVICES	0	-	-	5000
SAFETY EQUIPMENT	1,000	501	667.76	1000
TRAINING		-	-	0
INSURANCE & BONDS	7,000	5,124	6,832.00	6500
LAB/CHEMICALS	294	-	-	987
TOOLS	24	-	-	50
MISCELLANEOUS		269	358.40	
AQUA PROTECTION PERMIT	2,500	1,600	2,133.33	2200
DEPRECIATION		-	-	0
CONTINGENCY RESERVE	7,565	-	-	0
Transfer to Water Fund				53,791
Total Expenditures	171,750	123,508	164,677	243,104

Revenues	171,750	125,402	167,203	243,104
Expenditures	171,750	123,508	164,677	243,104

Revenue Over (Under) Expenditures	(0)	1,894	2,526	(0)
-----------------------------------	-----	-------	-------	-----

Beginning Unrestricted FB			273,853	276,379
Ending Net Position			276,379	202,207
Due From other Funds				

Mammoth Arizona

FY 2021-2022

Final Budget

Sanitation Department



Sanitation Department

TOWN OF MAMMOTH SANITATION FUND	Adopted Budget FY21	Actuals to 3-31-21 FY21	Estimated to 6-30-21 FY21	Proposed Budget FY22
<i>Utilities Revenue</i>				
REFUSE SERVICE CHARGE	134,000	95,437	127,250	120,000
ADEQ Surcharges	60	24	32	60
<i>Total Utilities Revenue</i>	134,060	95,461	127,282	120,060
<i>Expenditures</i>				
INSURANCE & BONDS	-	-	-	-
MISCELLANEOUS	39,060	250	333	5,060
CONTRACT FEES	95,000	81,908	109,211	115,000
<i>Total Expenditures</i>	134,060	82,158	109,544	120,060
Revenues	134,060	95,461	127,282	120,060
Expenditures	134,060	82,158	109,544	120,060
Revenue Over (Under) Expenditures	-	13,303	17,738	-
Beginning Unrestricted FB			204,853	222,591
Ending Unrestricted FB			222,591	222,591
Due (to)/From other Funds				

Mammoth Arizona

FY 2021-2022
Final Budget

Cemetery Department

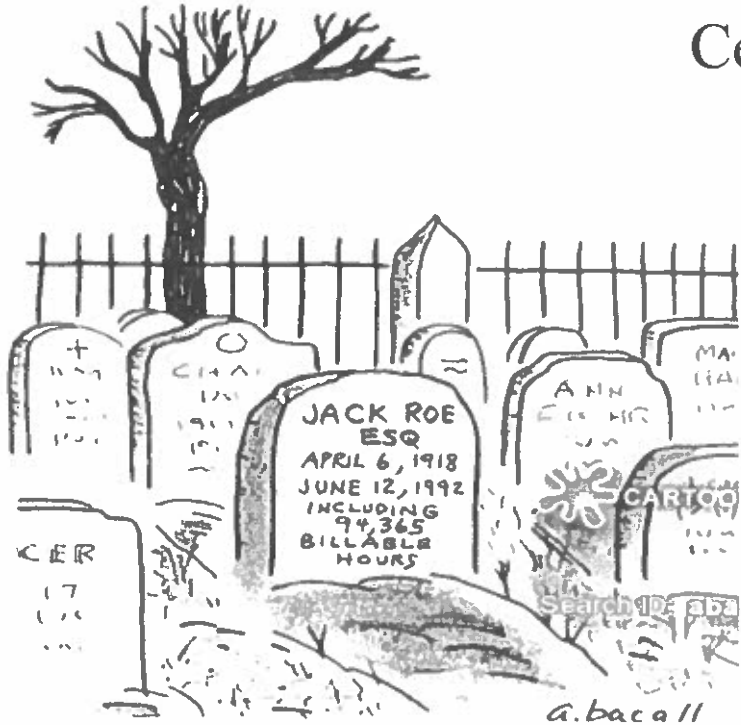

Cemetery Department

TOWN OF MAMMOTH CEMETARY FUND	Adopted Budget FY21	Actuals to 3-31-21 FY21	Estimated to 6-30-21 FY21	Proposed Budget FY22
<i>Cemetery Revenue</i>				
LOT SALES	7,000	6350	8,467	7,000
VAULT SALES	7,000	4050	5,400	5,000
OPEN & CLOSE	14,000	8284	11,045	10,000
MISCELLANEOUS REVENUE	2,400	2000	2,667	2,500
Total Utilities Revenue	30,400	20,684	27,579	24,500
Expenditures				
SALARIES & WAGES		-	-	-
EMPLOYEE BENEFITS		-	-	-
OFFICE SUPPLIES		175	234	200
VAULTS	4,200	2,327	3,103	3,000
EQUIPMENT MAINTENANCE		125	167	200
GROUNDS MAINTENANCE	2,000	1,571	2,095	2,000
AUDIT	2,000	-	-	2,000
INSURANCE & BONDS	2,700	-	-	2,700
MISCELLANEOUS	19,500	-	-	14,400
Total Expenditures	30,400	4,199	5,598	24,500
Revenues	30,400	20,684	27,579	24,500
Expenditures	30,400	4,199	5,598	24,500
Revenue Over (Under) Expend	-	16,485	21,980	-

Town Of Mammoth



RESOLUTION NO.: 2021-06

A RESOLUTION OF THE MAYOR AND TOWN COUNCIL OF THE TOWN OF MAMMOTH, ARIZONA, ADOPTING THE FISCAL YEAR 2021-2022 FINAL BUDGET IN THE AMOUNT OF \$8,784,427.

WHEREAS, the Town of Mammoth completes an annual budget, which must be balanced - revenues equaling expenses; and

WHEREAS, a final budget must be adopted by the Mayor and Town Council prior to the commencement of the new fiscal year; and

WHEREAS, the Town Clerk published in the manner prescribed by law, the estimates of expenditures, as hereinafter set forth, together with a notice that the Town Council will meet for the purpose of final hearing of taxpayers and for adoption of the 2021 - 2022 Annual Budget for the Town of Mammoth on the 30th day of June, 2021 at 6:00 p.m. in the Council Chambers at Mammoth Community Center. A public notice was also published that the Town Council will meet for the purpose of the hearing of taxpayers prior to the adoption of the 2021 - 2022 Tax Levy for the Town of Mammoth on the 15th day of July, 2021, at 6:00 p.m. in the Council Chambers at Town Hall of the Town of Mammoth; and

WHEREAS, the Town Council and staff have developed a balanced budget, which is now presented as the Fiscal Year 2021 – 2022 Final Budget.

NOW, THEREFORE, BE IT RESOLVED, by the Mayor and Town Council of the Town of Mammoth, Arizona that the Fiscal Year 2021 – 2022 Final Budget is adopted in the amount of \$8,784,427.

PASSED AND ADOPTED by the Mayor and Town Council of the Town of Mammoth, Arizona, this 30st day of June, 2021.

Patsy Armenta, Mayor

ATTEST:

APPROVED AS FORM:

Angela Sanchez, Town Clerk

Stephen R. Cooper Town Attorney

Handicapped individuals with special accessibility needs may contact the ADA Coordinator for the Town of Mammoth at (520) 487-2331 (V/TDD)

TOWN OF MAMMOTH
AGENDA ACTION FORM

AGENDA ITEM NO: _____	COUNCIL MEETING DATE: <u>June 30, 2021</u>
-----------------------	--

Agenda Action Forms must be submitted to the Town Clerk no later than 10 days prior to Town Council Meeting. Agenda Action Forms are subject to review by Mayor, Town Manager and/or Town Clerk for completion and accuracy.

NAME OF PERSON PROPOSING ITEM: Annie Martinez DATE SUBMITTED: June 23, 2021

BRIEF DESCRIPTION/SUMMARY OF THE AGENDA ITEM (AS YOU WOULD LIKE IT TO APPEAR):

Discuss to direct staff to evaluate current town space to renovate for quarters for police officers
to stay while on shift to reduce commute time and expense. This project is not to exceed \$12,000.

FISCAL IMPACT: \$12,000 (FISCAL IMPACT ON CURRENT BUDGET MUST BE COMPLETED)

TYPE OF ACTION REQUESTED:

INFORMATIONAL/DISCUSSION ONLY FORMAL ACTION-MOTION

RESOLUTION/ORDINANCE OTHER

TOWN CLERK'S RECOMMENDATION FOR PLACEMENT ON THE AGENDA: YES NO

RECOMMENDATION: _____

TOWN MANAGER/Town Clerk DATE (Section Completed by Staff)

MAYOR'S APPROVAL FOR PLACEMENT ON THE AGENDA: YES NO

Patsy Armenta 6/24/21
MAYOR DATE (Section Completed by Staff)

TOWN OF MAMMOTH
AGENDA ACTION FORM

AGENDA ITEM NO: _____	COUNCIL MEETING DATE: <u>June 30, 2021</u>
-----------------------	--

Agenda Action Forms must be submitted to the Town Clerk no later than 10 days prior to Town Council Meeting. Agenda Action Forms are subject to review by Mayor, Town Manager and/or Town Clerk for completion and accuracy.

NAME OF PERSON PROPOSING ITEM: Annie Martinez DATE SUBMITTED: June 23, 2021

BRIEF DESCRIPTION/SUMMARY OF THE AGENDA ITEM (AS YOU WOULD LIKE IT TO APPEAR):

Discuss assigning a take home vehicle to Police Chief (vehicle to be assigned Chevy Impala Plate #

FISCAL IMPACT: \$1,500 gas (FISCAL IMPACT ON CURRENT BUDGET MUST BE COMPLETED)

TYPE OF ACTION REQUESTED:

INFORMATIONAL/DISCUSSION ONLY FORMAL ACTION-MOTION

RESOLUTION/ORDINANCE OTHER

TOWN CLERK'S RECOMMENDATION FOR PLACEMENT ON THE AGENDA: YES NO

RECOMMENDATION: _____

TOWN MANAGER/Town Clerk DATE (Section Completed by Staff)

MAYOR'S APPROVAL FOR PLACEMENT ON THE AGENDA: YES NO

Patsy Armenta 6/24/21
MAYOR DATE (Section Completed by Staff)